



The Optimum Solution for Dairies

Unique PMO Plus® Mixproof Valve

Compliance

- Meets 3A/PMO Requirements Compliance - M-b 356

Concept

This Unique **PMO Plus**® Mixproof valve is based on the well proven and exceptionally flexible design of the Unique PMO Mixproof valves from Alfa Laval. It meets the demands from the 3A/PMO (Pasteurized Milk Ordinance paragraph 15p(B)) standards saying that all movements have to be detectable, as well as the vent tube has to have the same or greater area than the connection pipe. Furthermore, the Unique **PMO Plus**® meets the FDA demands for seat lift compliance M-b 356. This allows CIP flow to clean one chamber while product is running in the other chamber, thus eliminating CIP downtime. Finally, the actuator is fail safe by spring to close.

Working Principle

Unique **PMO Plus**® is remote-controlled by means of compressed air. The valve is a normally closed (NC) valve. The valve has two independent plug seals, forming a leakage chamber between them which is at atmospheric pressure or less during every working condition. In the rare case of fluid passing a valve seat, the fluid will enter the leakage chamber and be discharged through the leakage outlet. When the valve is open, the leakage chamber is closed.

Build-up

This **PMO Plus**® edition of the Unique Mixproof valve is a high-end valve with regards to process security as well as from a sanitary point of view. The valve plugs are always balanced in both upper and lower valve body, securing no sensitivity to pressure spikes. The lower and upper seats are position-detectable by the ThinkTop® and a yoke-mounted, external sensor. The Unique PMO Plus Mixproof valve is available in 1½" - 4" tube O.D. sizes.



Unique PMO Plus® Mixproof Valve with externally mounted indication.

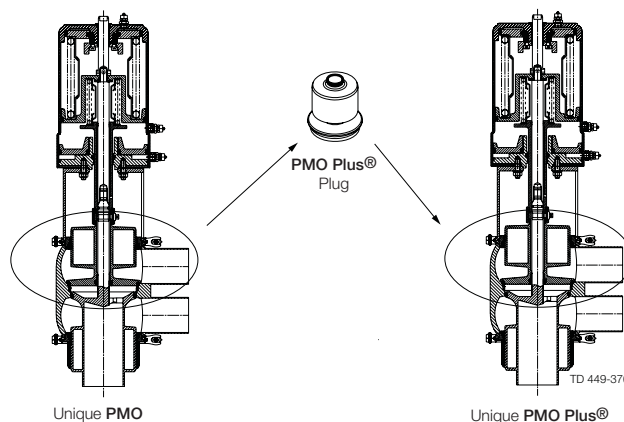

Dimensions [Inches]

Size	1½"	2"	2.5"	3"	4"
A	19.232	22.559	25.709	26.929	30.748
A*	26.319	29.646	32.795	34.016	37.835
B	6.693	8.661	11.811	11.811	11.811
**C	2.394	2.906	3.398	3.894	4.866
OD	1.500	2.008	2.500	2.996	4.000
ID	1.370	1.882	2.374	2.870	3.843
t	0.063	0.063	0.063	0.063	0.079
E	2.925	4.488	4.961	5.472	6.535
F1	1.240	1.240	1.496	1.496	2.323
F2	0.197	0.197	0.197	0.197	0.197
øD	4.724	4.724	6.181	6.181	7.323
L	9.055	9.055	9.921	9.921	11.063
M/Tri-clamp	0.827	0.827	0.827	0.827	0.827
Weight [lb]	33.000	33.000	53.000	53.000	75.000

NOTE!

**The measure C can always be calculated by the formula

$$C = \frac{1}{2}ID_{\text{upper}} + \frac{1}{2}ID_{\text{lower}} + 1"$$

Valve body combinations

TYPE 11-00

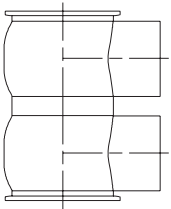

TYPE 11-90

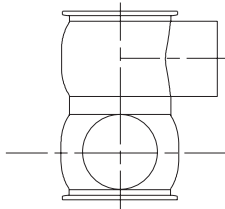

TYPE 11-180

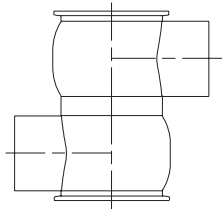

TYPE 11-270

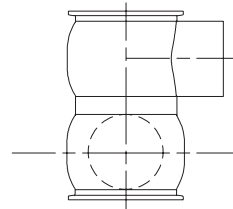

TYPE 12-00

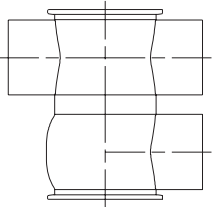

TYPE 12-90

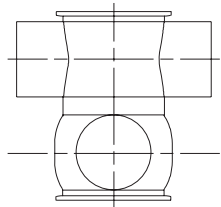

TYPE 21-00

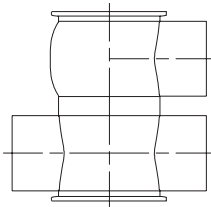

TYPE 21-90

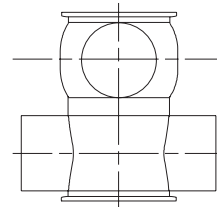

TYPE 22-00

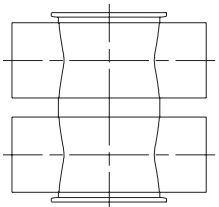

TYPE 22-90

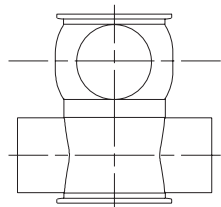

TD449-014_1

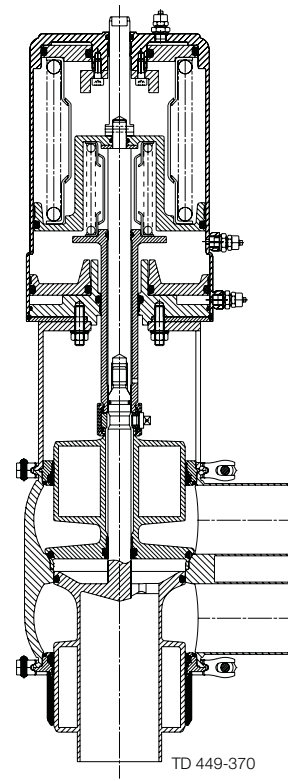
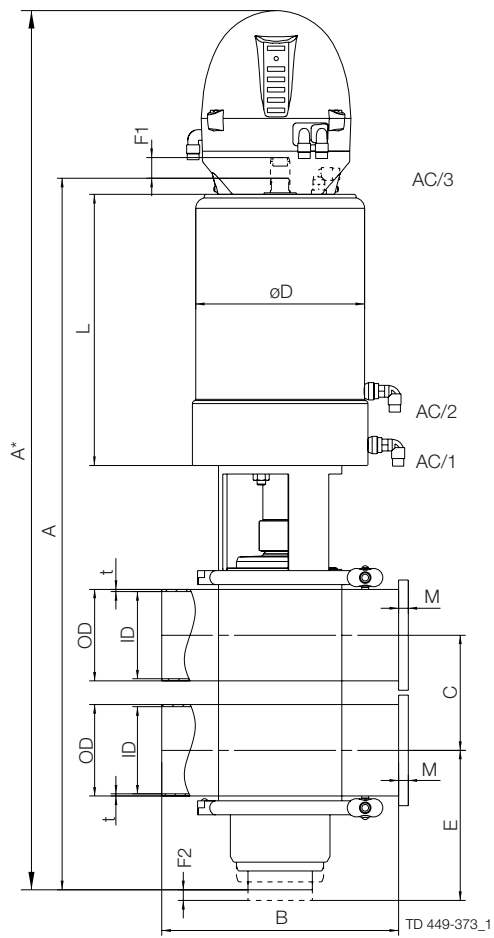

Fig. 1 Details of Unique **PMO Plus**® Mixproof Valve

Pressure drop/capacity diagrams

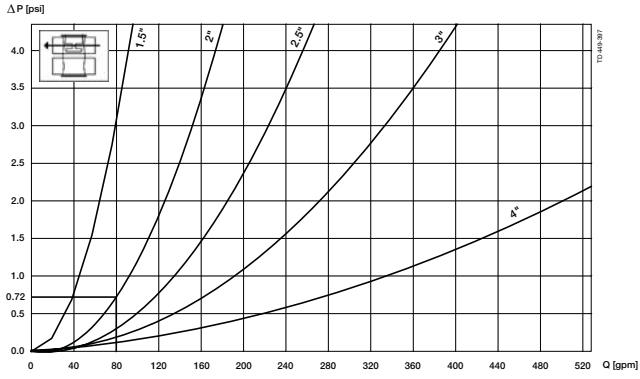

Fig. 2. Pressure drop/capacity diagram, upper bodies.

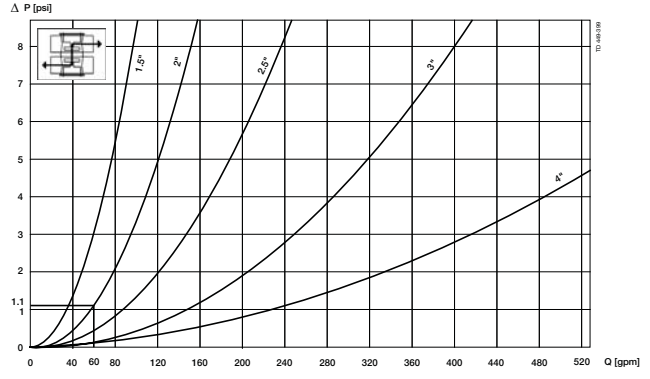

Fig. 3. Pressure drop/capacity diagram, between bodies.

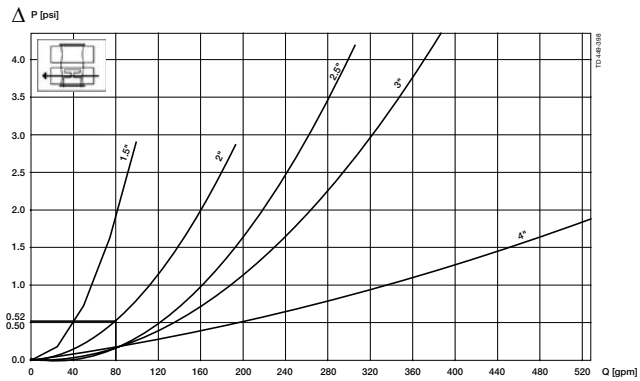

Fig. 4. Pressure drop/capacity diagram, lower body.

Example to determine pressure drop at a given flow rate:

Upper body size: 2". Capacity = 80 gpm.
 Lower body size: 2". Capacity = 80 gpm.
 Between bodies: 2". Capacity = 60 gpm.

Result:

From fig. 2, $\Delta p = 0.72$ psi through upper body.

From fig. 3, $\Delta p = 1.1$ psi between bodies.

From fig. 4, $\Delta p = 0.52$ psi through lower body.

Note!

For the diagrams the following applies:
 Medium: Water (68°F).
 Measurement: In accordance with VDI 2173.

Technical Data

Max. product pressure:145 psi (for higher pressure, please ask Alfa Laval)
 Min. product pressure:Full vacuum.
 Temperature range:23°F to +257°F (Depending on elastomer type)
 (For higher temperatures, please contact Alfa Laval)
 Air pressure:Max. 116 psi.

Size		OD 1½"	OD 2"	OD 2½"	OD 3"	OD 4"
Cv-value Upper Seat-lift	[gpm/psi]	1.7	2.6	3.9	3.9	5.3
Cv-value Lower Seat-lift	[gpm/psi]	1.0	2.2	3.6	3.6	4.9
Air consumption Upper Seat-lift	* [cubic inches]	12	12	24	24	38
Air consumption Lower Seat-lift	* [cubic inches]	67	67	8	8	13
Air consumption Main Movement	* [cubic inches]	52	52	99	99	170

$$Q = Cv \cdot \Delta p$$

Q = water flow [gpm]

Cv = value from the above table.

Δp =water pressure [psi]

Materials

Product wetted steel parts:Acid-resistant steel AISI 316L
 Other steel parts:Stainless steel AISI 304
 Product wetted parts:EPDM (std.), NBR, HNBR or FPM
 Other seals:CIP seals: EPDM.
 Actuator seals: NBR.
 Surface finish:External bright/internal polished Ra<32µ"

Ordering

For ordering, contact Alfa Laval.

Control & Indication for both upper and lower seat lift as well as main movement, is given via the ThinkTop® control unit.
 Please refer to ESE00521 ENUS, ESE00299 ENUS and ESE00298 ENUS for further information.

Alfa Laval reserves the right to change specifications without prior notification. ALFA LAVAL is a trademark registered and owned by Alfa Laval Corporate AB.

ESE00795US 1007

© Alfa Laval

How to contact Alfa Laval

Contact details for all countries are continually updated on our website. Please visit www.alfalaval.us to access the information direct.

 Authorized to carry the 3A symbol